



# MIL-DTL-5015 Type CONNECTORS



## Table of Contents

Page

Technical Specifications 5

### Contact and Insert Arrangements

Insert Alternate & Alternate Positioning	6
Contact Arrangements	8

### MIL-DTL-5015 Type

Wall Mounting Receptacle (I/MS3100)	16
In-Line Receptacle (I/MS3101)	17
Box Mounting Receptacle (I/MS3102)	19
Straight Plug (I/MS3106)	19
Right Angle Plug (I/MS3108)	21

### MIL-DTL-5015 Standard Accessories

Cable Clamp (I/MS3057)	22
Telescoping Bushing (I/MS3420)	22
Protective Cover for Receptacle (I/MS25043)	23
Protective Cover for Plug (I/MS25042)	23



# Technical Specifications

## [ Materials & Finishes ]

Shell, Endbell	Aluminum alloy / Olive drab chromate coating over cadmium or zinc plating
Insulator	Synthetic rubber
Contact	Copper alloy / Silver plating
Gasket and Grommet	Synthetic rubber

## [ Electrical Data ]

Operating Voltage Test Voltage	Service Rating	Operating Voltage DC V	Operating Voltage AC V r.m.s.	Test Voltage AC V r.m.s.	Air Spacing Nominal (Inches)	Creepage Nominal (Inches)
	Inst.	250	200	1000	-	1/16
	A	700	500	2000	1/16	1/8
	D	1250	900	2800	1/8	3/16
	E	1750	1250	3500	3/16	1/4
	B	2450	1750	4500	1/4	5/16
	C	4200	3000	7000	5/16	1

Current Rating at 68°F (+20°C)	Contact Size	Contact Resistance Milliohm Max.	Test Current (Amps)	Potential Drop (Millivolts)
	16	16	13	49
	12	3	23	42
	8	1	46	26
	4	0.5	80	23
	0	0.2	150	21

Insulator Resistance Min. 5000 MΩ at 77°F (+25°C) per MIL-DTL-5015, 3.18

## [ Mechanical ]

Operating Temperature -67°F (-55°C) to +257°F (+125°C)  
Sealing 48 hours in 6 feet of water per MIL-DTL-5015, 4.6.19.

Wire Sealing Range	Contact Size	Insulation Outside Diameter Limit			
		Min. (Inches)	Min. (mm)	Max. (Inches)	Max. (mm)
	16	0.064	1.63	0.130	3.30
	12	0.114	2.90	0.170	4.32
	8	0.164	4.17	0.255	6.48
	4	0.275	6.98	0.370	9.40
	0	0.145	10.54	0.550	13.97

Durability 100 cycles of mating / unmating operations to MIL-DTL-5015, 3.16  
Salt Spray MIL-STD-1344 Method 1001 Condition B, minimum (Cadmium) 48 hours  
Heat +257°F (+125°C) for 60 hours, +185°F (+85°C) for 1000 hours per MIL-DTL-5015, 4.6.14  
Chemical Resistance 20 hour full immersion unmated in hydraulic fluid and lubricating oil per MIL-DTL-5015  
Vibration 10 to 2000Hz (10G units) 10 microseconds maximum discontinuity to MIL-STD-1344 Method 2005, condition II per MIL-DTL-5015  
Shock 50G units 11 millisecond duration, three major axes. 10 microseconds maximum discontinuity to MIL-DTL-5015 per MIL-STD-1344 Method 2004, condition A

Contact Retention & Separation Forces	Contact Size	Axial Load		Separation Force Min.	
		Newtons	Lbs.	Newtons	Lbs.
	16	44	10	1	0.25
	12	67	15	2	0.50
	8	89	20	3	0.75
	4	89	20	4	1.00
	0	111	25	9	2.00

# Insert Arrangement & Alternate Positioning

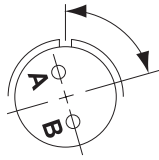

Position W

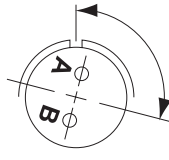

Position X

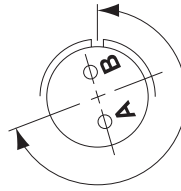

Position Y

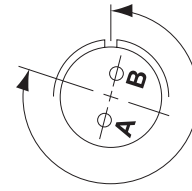

Position Z

View looking into front face of pin insert or rear of socket insert.

Insert Arrangement	Service Rating	Total Contacts	Contact Size					Alternate Position Degrees			
			0	4	8	12	16	W	X	Y	X
10SL-3	A	3					3	-	-	-	-
10SL-4	A	2					2	-	-	-	-
12S-3	A	2					2	70	145	215	290
12S-4	D	1					1	-	-	-	-
14S-1	A	3					3	-	-	-	-
14S-2	Inst.	4					4	-	120	240	-
14S-4	D	1					1	-	-	-	-
14S-5	Inst.	5					5	-	110	-	-
14S-6	Inst.	6					6	-	-	-	-
14S-7	A	3					3	90	180	270	-
14S-9	A	2					2	70	145	215	290
16S-1	A	7					7	80	-	-	280
16S-3	B	1					1	-	-	-	-
16S-4	D	2					2	35	110	250	325
16S-5	A	3					3	70	145	215	290
16S-6	A	3					3	90	180	270	-
16S-8	A	5					5	-	170	265	-
16-2	E	1				1		-	-	-	-
16-7	A	3			1		2	80	110	250	280
16-9	A	4				2	2	35	110	250	325
16-10	A	3				3		90	180	270	-
16-11	A	2				2		35	110	250	325
16-12	A	1		1				-	-	-	-
16-13	A	2				2		35	110	250	325
18-1	A/Inst.	10					10	70	145	215	290
18-3	D	2				2		35	110	250	325
18-4	D	4				4		35	110	250	325
18-5	D	3				2	1	80	110	250	280
18-6	D	1		1				-	-	-	-
18-7	B	1			1			-	-	-	-
18-8	A	8				1	7	70	-	-	290
18-9	Inst.	7				2	5	80	110	250	280
18-10	A	4				4		-	120	240	-
18-11	A	5				5		-	170	265	-
18-12	A	6					6	80	-	-	280
18-13	A	4			1	3		80	110	250	280
18-14	A	2		1			1	80	110	250	280
18-15	A	4				4		-	120	240	-
18-16	C	1				1		-	-	-	-

Insert Arrangement	Service Rating	Total Contacts	Contact Size					Alternate Position Degrees			
			0	4	8	12	16	W	X	Y	X
18-20	A	5					5	90	180	270	-
18-22	D	3					3	70	145	215	290
18-29	A	5					5	90	180	270	-
20-3	D	3				3		70	145	215	290
20-4	D	4				4		45	110	250	-
20-6	D	3					3	70	145	215	290
20-7	D/A	8					8	80	110	250	280
20-8	Inst.	6			2		4	80	110	250	280
20-9	D/A	8				1	7	80	110	250	280
20-11	Inst.	13					13	-	-	-	-
20-12	A	2		1			1	80	110	250	280
20-14	A	5			2	3		80	110	250	280
20-15	A	7				7		80	-	-	280
20-16	A	9				2	7	80	110	250	280
20-17	A	6				5	1	90	180	270	-
20-18	A	9				3	6	35	110	250	325
20-19	A	3			3			90	180	270	-
20-20	A	4		1		3		80	110	250	280
20-21	A	9				1	8	35	110	250	325
20-22	A	6			3		3	80	110	250	280
20-23	A	2			2			35	110	250	325
20-24	A	4			2		2	35	110	250	325
20-27	A	14					14	35	110	250	325
20-29	A	17					17	80	-	-	280
20-33	A	11					11	-	-	-	-
22-1	D	2			2			35	110	250	325
22-2	D	3			3			70	145	215	290
22-4	A	4			2	2		35	110	250	325
22-5	D	6				2	4	35	110	250	325
22-6	D	3			2		1	80	110	250	280
22-7	E	1		1				-	-	-	-
22-8	E	2				2		35	110	250	325
22-9	E	3				3		70	145	215	290
22-10	E	4					4	35	110	250	325
22-11	B	2					2	35	110	250	325
22-12	D	5			2		3	80	110	250	280
22-13	D/A	5				4	1	35	110	250	325
22-14	A	19					19	80	110	250	280
22-15	E/A	6				5	1	80	110	250	280

# Insert Arrangement & Alternate Positioning

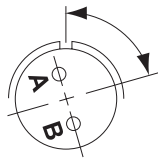

Position W

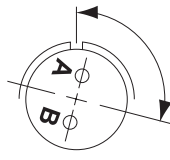

Position X

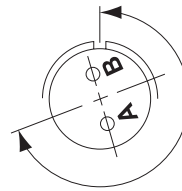

Position Y

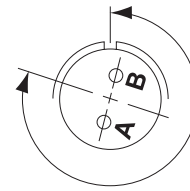

Position Z

View looking into front face of pin insert or rear of socket insert.

Insert Arrangement	Service Rating	Total Contacts	Contact Size					Alternate Position Degrees			
			0	4	8	12	16	W	X	Y	X
22-16	A	9				3	6	80	110	250	280
22-17	D/A	9				1	8	80	110	250	280
22-18	A/D	8					8	80	110	250	280
22-19	A	14					14	80	110	250	280
22-20	A	9					9	35	110	250	325
22-21	A	3	1				2	80	110	250	280
22-22	A	4			4			-	110	250	-
22-23	D/A	8				8		35	-	250	-
22-24	D/A	6				2	4	80	110	250	280
22-27	D/A	9			1		8	80	-	250	280
22-28	A	7				7		80	-	-	280
22-33	A/D	7					7	80	110	250	280
22-34	D	5				3	2	80	110	250	280
22-36	D/A	8				8		90	-	270	-
24-2	D	7				7		80	-	-	280
24-3	D	7				2	5	80	110	250	280
24-5	A	16					16	80	110	250	280
24-6	D/A	8				8		80	110	250	280
24-7	A	16				2	14	80	110	250	280
24-9	A	2		2				35	110	250	325
24-10	A	7			7			80	-	-	280
24-11	A	9			3	6		35	110	250	325
24-12	A	5		2		3		80	110	250	280
24-16	D/A	7			1	3	3	80	110	250	280
24-17	D	5				2	3	80	110	250	280
24-20	D	11				2	9	80	110	250	280
24-21	D	10				1	9	80	110	250	280
24-22	D	4			4			45	110	250	-
24-27	E	7					7	80	-	-	280
24-28	Inst.	24					24	80	110	250	280
28-1	D/A	9			3	6		80	110	250	280
28-2	D	14				2	12	35	110	250	325
28-3	E	3			3			70	145	215	290
28-4	E/D	9				2	7	80	110	250	280
28-5	D	5		2		1	2	35	110	250	325
28-6	D	3		3				70	145	215	290
28-8	E/D/A	12				2	10	80	110	250	280
28-9	D	12				6	6	80	110	250	280
28-10	D/A	7		2	2	3		80	110	250	280

Insert Arrangement	Service Rating	Total Contacts	Contact Size					Alternate Position Degrees				
			0	4	8	12	16	W	X	Y	X	
28-11	A	22				4	18	80	110	250	280	
28-12	A	26					26	90	180	270	-	
28-15	A	35					35	80	110	250	280	
28-16	A	20					20	80	110	250	280	
28-17	B/D/A	15					15	80	110	250	280	
28-18	C/A/Inst/D	12					12	70	145	215	290	
28-19	B/D/A	10				4	6	80	110	250	280	
28-20	A	14				10	4	80	110	250	280	
28-21	A	37					37	80	110	250	280	
28-22	D	6		3			3	70	145	215	290	
32-1	E/D	5	2				3	80	110	250	280	
32-2	E	5		3			2	70	145	215	290	
32-3	D	9	1	2			2	4	80	110	250	280
32-4	D/A	14					2	12	80	110	250	280
32-5	D	2	2					80	110	250	325	
32-6	A	23		2	3	2	16	80	110	250	280	
32-7	Inst./A	35					7	28	80	125	235	280
32-8	A	30				6	24	80	125	235	280	
32-9	D	14		2				12	80	110	250	280
32-10	E/B/D/A	7		2	2			3	80	110	250	280
32-12	A/D	15					5	10	80	110	250	280
32-13	D	23					5	18	80	110	250	280
32-15	D	8	2				6	35	110	250	280	
32-17	D	4		4				45	110	250	-	
36-1	D	22					4	18	80	110	250	280
36-3	D	6	3				3	70	145	215	290	
36-4	D/A	3	3					70	145	215	290	
36-5	A	4	4					-	120	240	-	
36-6	A	6	2	4				35	110	250	325	
36-7	A	47					7	40	80	110	250	280
36-8	A	47					1	46	80	110	250	280
36-9	A	31		1	2	14	14	80	125	235	280	
36-10	A	48						48	80	125	235	280
36-13	E/A	17					2	15	80	110	250	280
36-14	D	16				5	5	6	90	180	270	-
36-15	D/A	35						35	60	125	245	305
36-52	A	52						52	72	144	216	288

# Contact Arrangement

Front face of pin insert or rear face of socket insert illustrated.

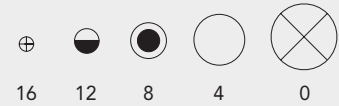

## 1 CONTACT

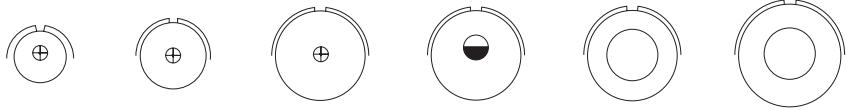

Insert Arrangement	12S-4	14S-4	16S-3	16-2	16-12	18-6
Contact Size - No. of Contacts	#16-1	#16-1	#16-1	#12-1	#4-1	#4-1
Service Rating	D	D	B	E	A	D

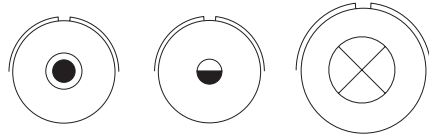

Insert Arrangement	18-7	18-16	22-7
Contact Size - No. of Contacts	#8-1	#12-1	#0-1
Service Rating	B	C	E

## 2 CONTACTS

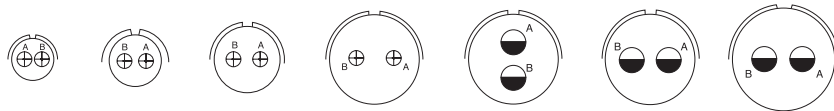

Insert Arrangement	10SL-4	12S-3	14S-9	16S-4	16-11	16-13	18-3
Contact Size - No. of Contacts	#16-2	#16-2	#16-2	#16-2	#12-2	#12-2	#12-2
Service Rating	A	A	A	D	A	A	D

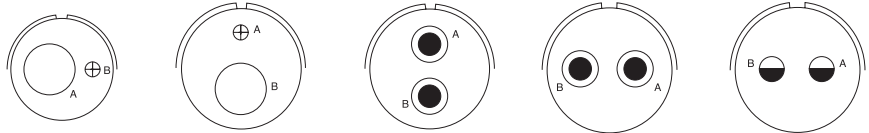

Insert Arrangement	18-14	20-12	20-23	22-1	22-8
Contact Size - No. of Contacts	#16-1, #4-1	#16-1, #4-1	#8-2	#8-2	#12-2
Service Rating	A	A	A	D	E

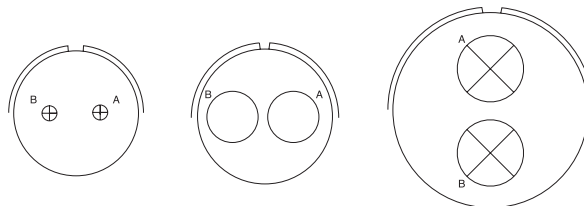

Insert Arrangement	22-11	24-9	32-5
Contact Size - No. of Contacts	#16-2	#4-2	#0-2
Service Rating	B	A	D

## Contact Arrangement

Front face of pin insert or rear face of socket insert illustrated.

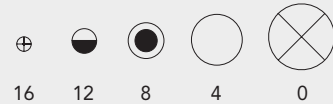

### 3 CONTACTS

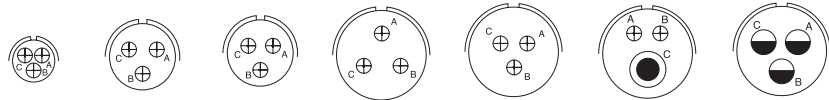

Insert Arrangement	10SL-3	14S-1	14S-7	16S-5	16S-6	16-7	16-10
Contact Size - No. of Contacts	#16-3	#16-3	#16-3	#16-3	#16-3	#16-2, #8-1	#12-3
Service Rating	A	A	A	A	A	A	A

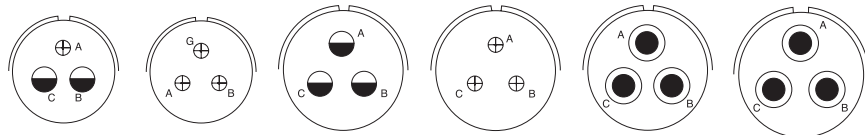

Insert Arrangement	18-5	18-22	20-3	20-6	20-19	22-2
Contact Size - No. of Contacts	#16-1, #12-2	#16-3	#12-3	#16-3	#8-3	#8-3
Service Rating	D	D	D	D	A	D

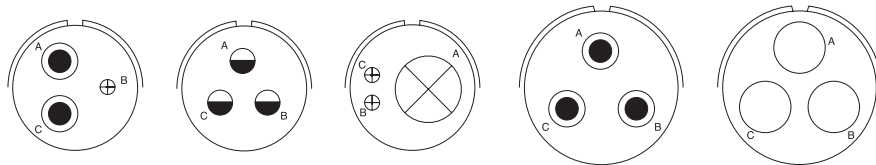

Insert Arrangement	22-6	22-9	22-21	28-3	28-6
Contact Size - No. of Contacts	#16-1, #8-2	#12-3	#16-2, #0-1	#8-3	#4-3
Service Rating	D	E	A	E	D

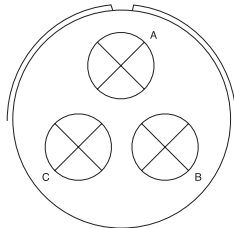

Insert Arrangement	36-4
Contact Size - No. of Contacts	#0-3
Service Rating	D(A) / A(B,C)

### 4 CONTACTS

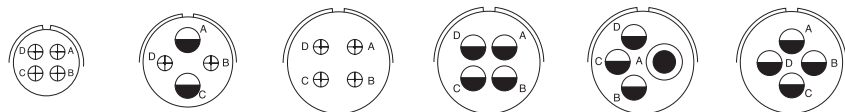

Insert Arrangement	14S-2	16-9	18-4	18-10	18-13	18-15
Contact Size - No. of Contacts	#16-4	#16-2, #12-2	#16-4	#12-4	#12-3, #8-1	#12-4
Service Rating	Inst.	A	D	A	A	A

# Contact Arrangement

Front face of pin insert or rear face of socket insert illustrated.



## 4 CONTACTS

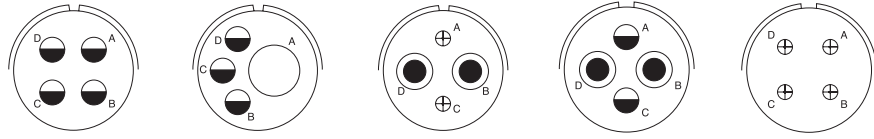

Insert Arrangement	20-4	20-20	20-24	22-4	22-10
Contact Size - No. of Contacts	#12-4	#12-3, #4-1	#16-2, #8-2	#12-2, #8-2	#16-4
Service Rating	D	A	A	A	E

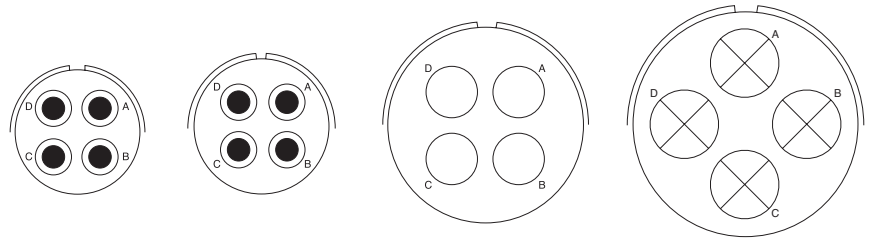

Insert Arrangement	22-22	24-22	32-17	36-5
Contact Size - No. of Contacts	#8-4	#8-4	#4-4	#0-4
Service Rating	A	D	D	A

## 5 CONTACTS

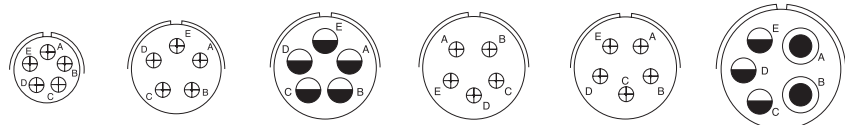

Insert Arrangement	14S-5	16S-8	18-11	18-20	18-29	20-14
Contact Size - No. of Contacts	#16-5	#16-5	#12-5	#16-5	#16-5	#12-3, #8-2
Service Rating	Inst.	A	A	A	A	A

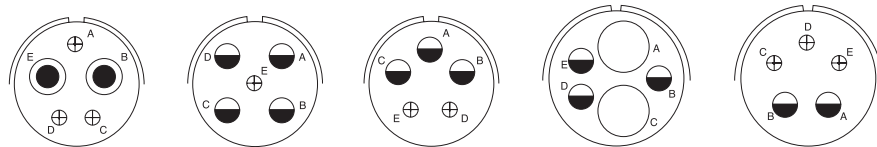

Insert Arrangement	22-12	22-13	22-34	24-12	24-17
Contact Size - No. of Contacts	#16-3, #8-2	#16-1, #12-4	#16-2, #12-3	#12-3, #4-2	#16-3, #12-2
Service Rating	D	D(E) / A(All others)	D	A	D

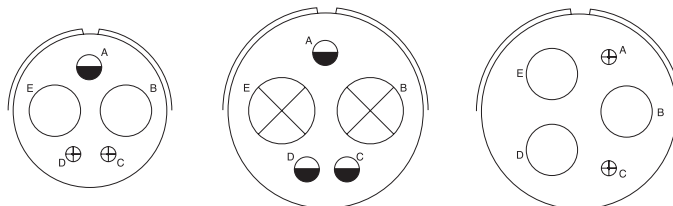

Insert Arrangement	28-5	32-1	32-2
Contact Size - No. of Contacts	#16-2, #12-1, #4-2	#12-3, #0-2	#16-2, #4-3
Service Rating	D	E(A) / D(All others)	E

# Contact Arrangement

Front face of pin insert or rear face of socket insert illustrated.



## 6 CONTACTS

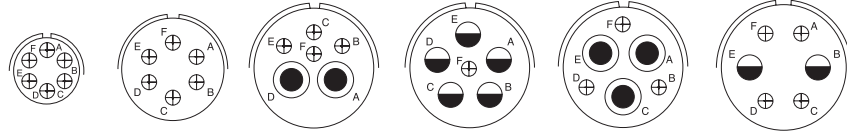

Insert Arrangement	14S-6	18-12	20-8	20-17	20-22	22-5
Contact Size - No. of Contacts	#16-6	#16-6	#16-4, #8-2	#16-1, #12-5	#16-3, #8-3	#16-4, #12-2
Service Rating	Inst.	A	Inst.	A	A	D

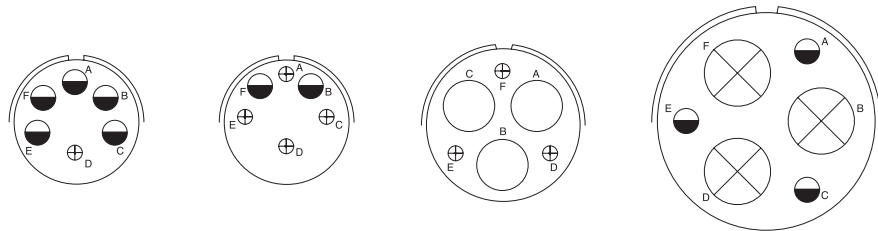

Insert Arrangement	22-15	22-24	28-22	36-3
Contact Size - No. of Contacts	#16-1, #12-5	#16-4, #12-2	#16-3, #4-3	#12-3, #0-3
Service Rating	E(D) / A(All others)	D(C, D, E) / A(All others)	D	D

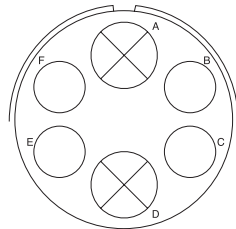

Insert Arrangement	36-6
Contact Size - No. of Contacts	#4-4, #0-2
Service Rating	A

## 7 CONTACTS

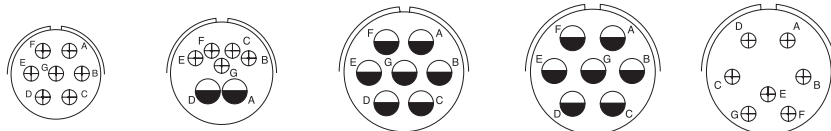

Insert Arrangement	16S-1	18-9	20-15	22-28	22-33
Contact Size - No. of Contacts	#16-7	#16-5, #12-2	#12-7	#12-7	#16-7
Service Rating	A	Inst	A	A	A(E, F, G) / D(All others)

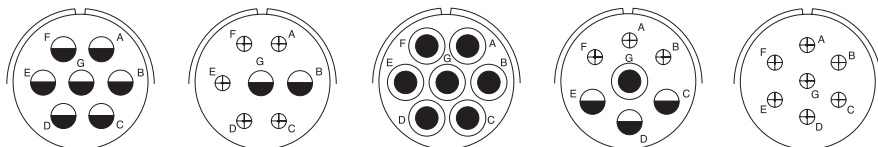

Insert Arrangement	24-2	24-3	24-10	24-16	24-27
Contact Size - No. of Contacts	#12-7	#16-5, #12-2	#8-7	#16-3, #12-3, #8-1	#16-7
Service Rating	D	D	A	D(A, B, F, G) / A(All others)	E

MIL-DTL-5015 Type



# Contact Arrangement

Front face of pin insert or rear face of socket insert illustrated.

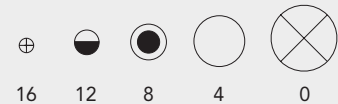

## 7 CONTACTS

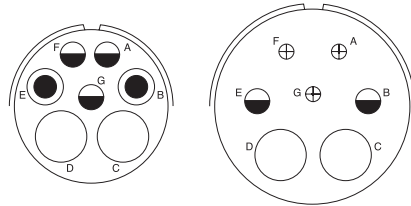

Insert Arrangement	28-10	32-10
Contact Size - No. of Contacts	#12-3, #8-2, #4-2	#16-3, #8-2, #4-2
Service Rating	D(G) / A(Bal.)	E(A, F) / B(G) / D(B, E) / A(C, D)

## 8 CONTACTS

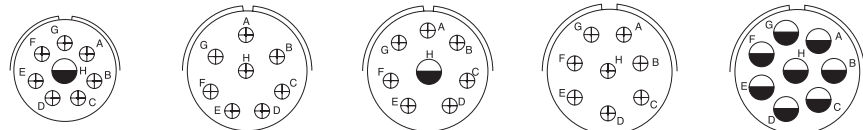

Insert Arrangement	18-8	20-7	20-9	22-18	22-23
Contact Size - No. of Contacts	#16-7, #12-1	#16-8	#16-7, #12-1	#16-8	#12-8
Service Rating	A	D(A, B, H, G) / A(All others)	D(H) / A(All others)	A(C, D, E) / D(All others)	D(H) / A(All others)

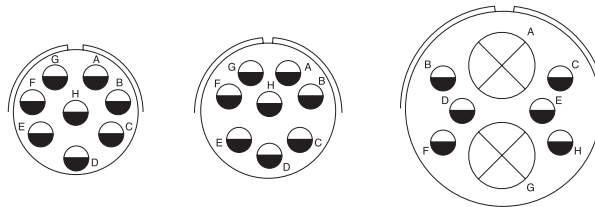

Insert Arrangement	22-36	24-6	32-15
Contact Size - No. of Contacts	#12-8	#12-8	#16-6, #0-2
Service Rating	D(H) / A(All others)	D(A, G, H) / A(All others)	D

## 9 CONTACTS

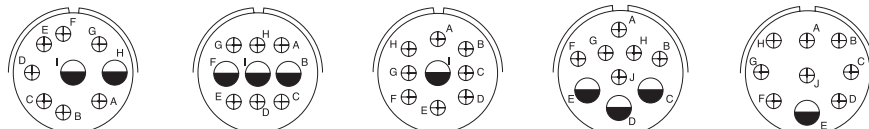

Insert Arrangement	20-16	20-18	20-21	22-16	22-17
Contact Size - No. of Contacts	#16-7, #12-2	#16-6, #12-3	#16-8, #12-1	#16-6, #12-3	#16-8, #12-1
Service Rating	A	A	A	A	D(A) / A(All others)

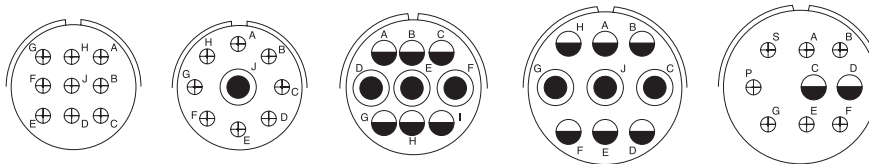

Insert Arrangement	22-20	22-27	24-11	28-1	28-4
Contact Size - No. of Contacts	#16-9	#16-8, #8-1	#12-6, #8-3	#12-6, #8-3	#16-7, #12-2
Service Rating	A	D(J) / A(All others)	A	D(A, J, E) / A(Bal.)	E(G, P, S) / D(Bal.)

## Contact Arrangement

Front face of pin insert or rear face of socket insert illustrated.



### 9 CONTACTS

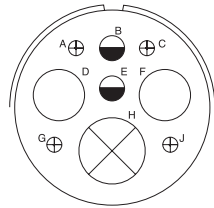

Insert Arrangement	32-3
Contact Size - No. of Contacts	#16-4, #12-2, #4-2, #0-1
Service Rating	D

### 10 CONTACTS

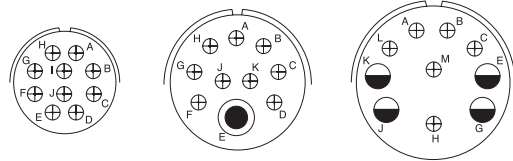

18-1	24-21	28-19
#16-10	#16-9, #8-1	#16-6, #12-4
A(B, C, F, G) / Inst.(All others)	D	B(H, M) / D(A, B) / A(All others.)

### 11 CONTACTS

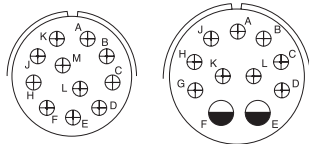

Insert Arrangement	20-33	24-20
Contact Size - No. of Contacts	#16-11	#16-9, #12-2
Service Rating	A	D

### 12 CONTACTS

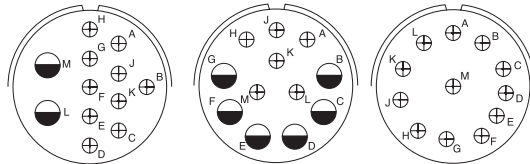

28-8	28-9	28-18
#16-10, #12-2	#16-6, #12-6	#16-12
E(L, M) / D(B) / A(All others)	D	C(M) / A(A, B) Inst.(C, D, E, F) / D(All others)

### 13 CONTACTS

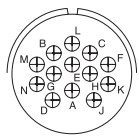

Insert Arrangement	20-11
Contact Size - No. of Contacts	#16-13
Service Rating	Inst.

### 14 CONTACTS

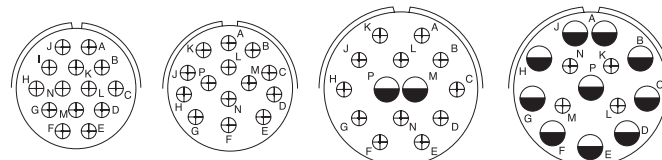

20-27	22-19	28-2	28-20
#16-14	#16-14	#16-12, #12-2	#16-4, #12-10
A	A	D	A

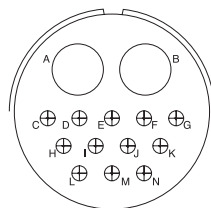
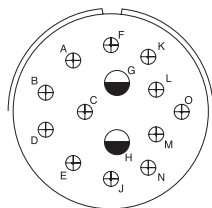

Insert Arrangement	32-4	32-9
Contact Size - No. of Contacts	#16-12, #12-2	#16-12, #4-2
Service Rating	A(F, J, K, N) / D(Bal.)	D

# Contact Arrangement

Front face of pin insert or rear face of socket insert illustrated.



## 15 CONTACTS

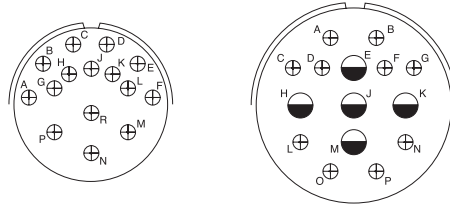

Insert Arrangement	28-17	32-12
Contact Size - No. of Contacts	#16-15	#16-10, #12-5
Service Rating	B(R) / D(M, N, P) / A(All others)	A(C, D, E, F, G) / D(Bal.)

## 16 CONTACTS

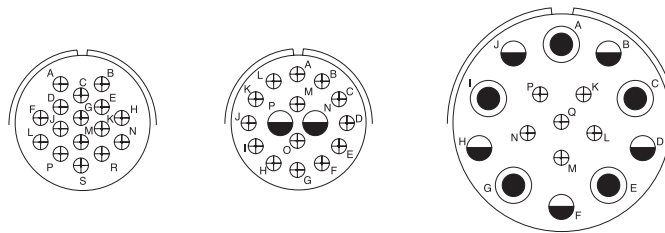

Insert Arrangement	24-5	24-7	36-14
Contact Size - No. of Contacts	#16-16	#16-14, #12-2	#16-6, #12-5, #8-5
Service Rating	A	A	D

## 17 CONTACTS

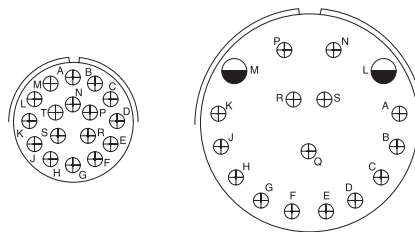

Insert Arrangement	20-29	36-13
Contact Size - No. of Contacts	#16-17	#16-15, #12-2
Service Rating	A	E(N, P, Q) / A(All others.)

## 19 CONTACTS

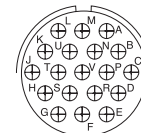

Insert Arrangement	22-14
Contact Size - No. of Contacts	#16-19
Service Rating	A

## 20 CONTACTS

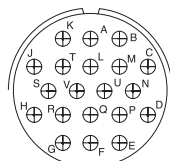

Insert Arrangement	28-16
Contact Size - No. of Contacts	#16-20
Service Rating	A

## 22 CONTACTS

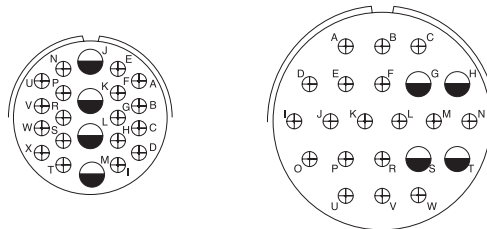

Insert Arrangement	28-11	36-1
Contact Size - No. of Contacts	#16-18, #12-4	#16-18, #12-4
Service Rating	A	D

# Contact Arrangement

Front face of pin insert or rear face of socket insert illustrated.



## 23 CONTACTS

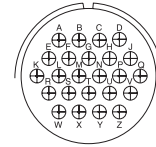
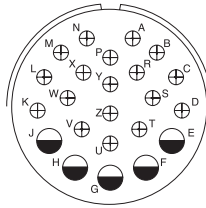
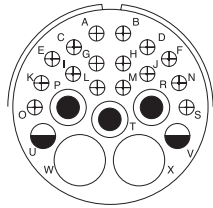

Insert Arrangement	32-6	32-13
Contact Size - No. of Contacts	#16-16, #12-2, #8-3, #4-2	#16-18, #12-5
Service Rating	A	D

## 24 CONTACTS

## 26 CONTACTS

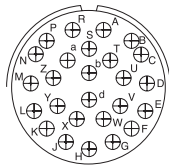

## 30 CONTACTS

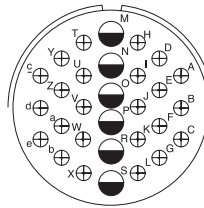

## 31 CONTACTS

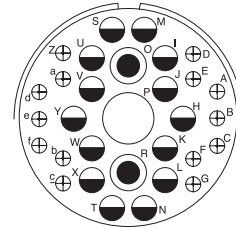

Insert Arrangement	28-12
Contact Size - No. of Contacts	#16-26
Service Rating	A

Insert Arrangement	32-8
Contact Size - No. of Contacts	#16-24, #12-6
Service Rating	A

Insert Arrangement	36-9
Contact Size - No. of Contacts	#16-14, #12-14, #8-2, #4-1
Service Rating	A

## 35 CONTACTS

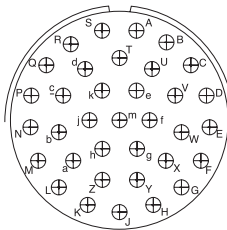
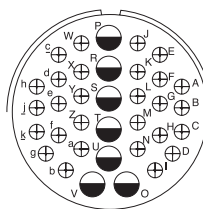
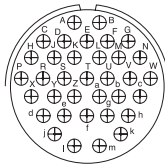

## 37 CONTACTS

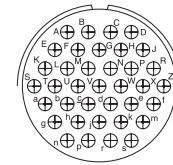

Insert Arrangement	28-15	32-7	36-15
Contact Size - No. of Contacts	#16-35	#16-28, #12-7	#16-35
Service Rating	A	Inst.(A, B, h, j) / A(All others)	D(M) / A(All others)

Insert Arrangement	28-21
Contact Size - No. of Contacts	#16-37
Service Rating	A

## 47 CONTACTS

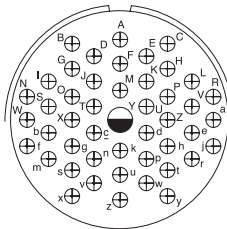
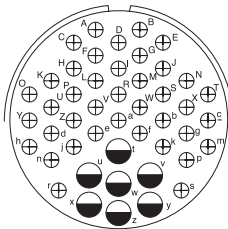

## 48 CONTACTS

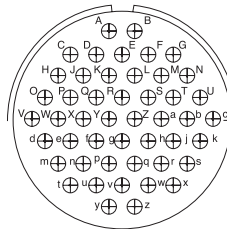

## 52 CONTACTS

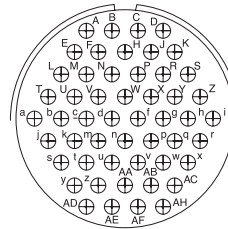

Insert Arrangement	36-7	36-8
Contact Size - No. of Contacts	#16-40, #12-7	#16-46, #12-1
Service Rating	A	A

Insert Arrangement	36-10
Contact Size - No. of Contacts	#16-48
Service Rating	A

Insert Arrangement	36-52
Contact Size - No. of Contacts	#16-52
Service Rating	A

MIL-DTL-5015 Type

## I/MS3100A Wall Mounting Receptacle

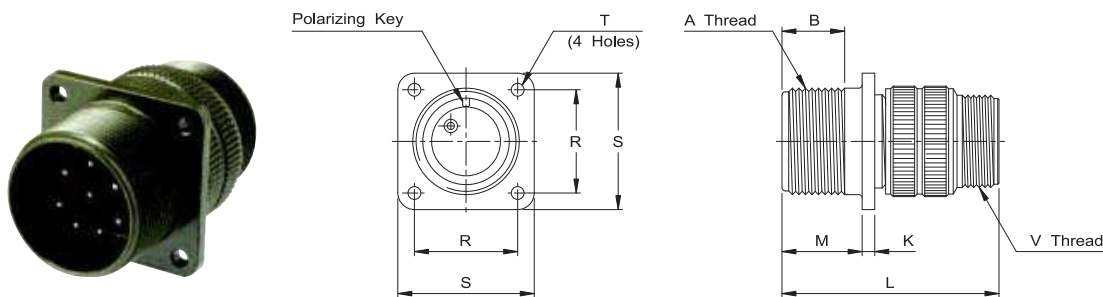

Part No.	A Thread Class 2A	B min.	K min./max.	L Ref.	M +0.79 -0.00	R ±0.12	S ±0.79	T dia. +0.25 -0.12	V Thread Class 2A
I/MS3100A 10SL*	5/8-24 UNEF	9.53	1.58 / 3.96	38.88	14.28	18.26	25.40	3.05	5/8-24 UNEF
I/MS3100A 12S*	3/4-20 UNEF	9.53	1.58 / 3.96	42.87	14.28	20.62	27.79	3.05	5/8-24 UNEF
I/MS3100A 14S*	7/8-20 UNEF	9.53	1.58 / 3.96	42.87	14.28	23.01	30.18	3.05	3/4-20 UNEF
I/MS3100A 16S*	1-20 UNEF	9.53	1.58 / 3.96	42.87	14.28	24.61	32.54	3.05	7/8-20 UNEF
I/MS3100A 16*	1-20 UNEF	15.88	1.58 / 3.96	52.37	19.05	24.61	32.54	3.05	7/8-20 UNEF
I/MS3100A 18*	1 1/8-18 UNEF	15.88	2.39 / 5.15	52.37	19.05	26.97	34.93	3.05	1-20 UNEF
I/MS3100A 20*	1 1/4-18 UNEF	15.88	2.39 / 5.15	55.57	19.05	29.36	38.10	3.05	1 3/16-18 UNEF
I/MS3100A 22*	1 3/8-18 UNEF	15.88	2.39 / 5.15	55.57	19.05	31.75	41.28	3.05	1 3/16-18 UNEF
I/MS3100A 24*	1 1/2-18 UNEF	15.88	2.39 / 5.15	58.72	20.63	34.93	44.45	3.73	1 7/16-18 UNEF
I/MS3100A 28*	1 3/4-18 UNS	15.88	2.39 / 5.15	58.72	20.63	39.67	50.80	3.73	1 7/16-18 UNEF
I/MS3100A 32*	2-18 UNS	15.88	3.18 / 9.11	61.92	22.23	44.45	57.15	4.39	1 3/4-18 UNS
I/MS3100A 36*	2 1/4-16 UN	15.88	3.18 / 9.11	61.92	22.23	49.23	63.50	4.39	2-18 UNS

## I/MS3100E or F Wall Mounting Receptacle

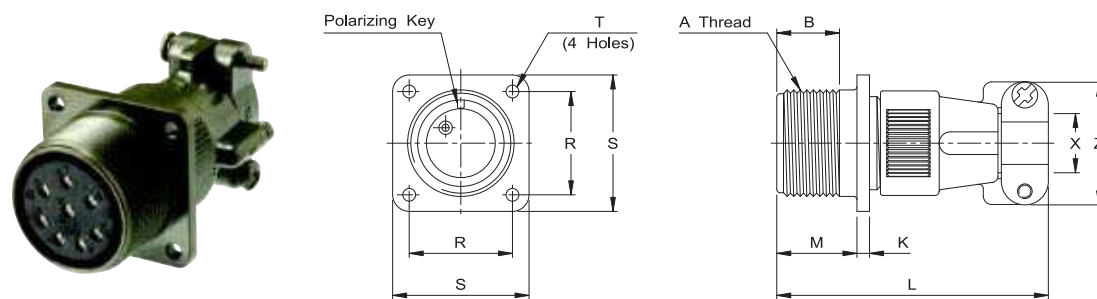

Part No.	A Thread Class 2A	B min.	K min./max.	L Ref.	M +0.79 -0.00	R ±0.12	S ±0.79	T dia. +0.25 -0.12	X min. Cable- range	Z max.
I/MS3100E/F 10SL*	5/8-24 UNEF	9.53	1.98 / 3.96	57.15	14.28	18.26	25.40	3.05	7.14	28.57
I/MS3100E/F 12S*	3/4-20 UNEF	9.53	1.98 / 3.96	57.15	14.28	20.62	27.79	3.05	7.14	28.57
I/MS3100E/F 14S*	7/8-20 UNEF	9.53	1.98 / 3.96	57.15	14.28	23.01	30.18	3.05	10.32	34.11
I/MS3100E/F 16S*	1-20 UNEF	9.53	1.98 / 3.96	57.15	14.28	24.61	32.54	3.05	12.70	37.69
I/MS3100E/F 16*	1-20 UNEF	15.88	1.98 / 3.96	66.67	19.05	24.61	32.54	3.05	12.70	37.69
I/MS3100E/F 18*	1 1/8-18 UNEF	15.88	2.39 / 5.15	68.27	19.05	26.97	34.93	3.05	13.49	40.86
I/MS3100E/F 20*	1 1/4-18 UNEF	15.88	2.39 / 5.15	69.85	19.05	29.36	38.10	3.05	16.67	48.00
I/MS3100E/F 22*	1 3/8-18 UNEF	15.88	2.39 / 5.15	69.85	19.05	31.75	41.28	3.05	18.80	48.00
I/MS3100E/F 24*	1 1/2-18 UNEF	15.88	2.39 / 5.15	75.41	20.63	34.93	44.45	3.73	19.84	55.11
I/MS3100E/F 28*	1 3/4-18 UNS	15.88	2.39 / 5.15	76.98	20.63	39.67	50.80	3.73	23.42	55.11
I/MS3100E/F 32*	2-18 UNS	15.88	3.18 / 9.11	76.98	22.23	44.45	57.15	4.39	29.36	67.46
I/MS3100E/F 36*	2 1/4-16 UN	15.88	3.18 / 9.11	83.33	22.23	49.23	63.50	4.39	31.75	74.21

## I/MS3100R Wall Mounting Receptacle

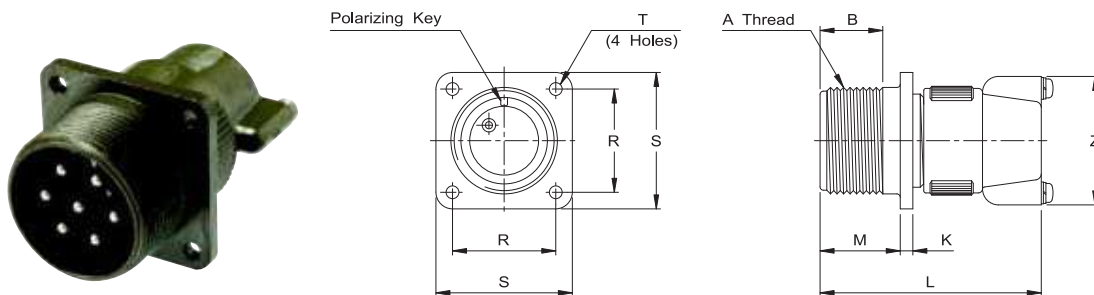

Part No.	A Thread Class 2A	B min.	K min./max.	L Ref.	M +0.79 -0.00	R ±0.12	S ±0.79	T dia. +0.25 -0.12	Z max.
I/MS3100R 10SL*	5/8-24 UNEF	9.53	1.98 / 3.96	46.68	14.28	18.26	25.40	3.05	28.57
I/MS3100R 12S*	3/4-20 UNEF	9.53	1.98 / 3.96	46.68	14.28	20.62	27.79	3.05	28.57
I/MS3100R 14S*	7/8-20 UNEF	9.53	1.98 / 3.96	46.68	14.28	23.01	30.18	3.05	34.11
I/MS3100R 16S*	1-20 UNEF	9.53	1.98 / 3.96	46.68	14.28	24.61	32.54	3.05	37.69
I/MS3100R 16*	1-20 UNEF	15.88	1.98 / 3.96	55.39	19.05	24.61	32.54	3.05	37.69
I/MS3100R 18*	1 1/8-18 UNEF	15.88	2.39 / 5.15	57.93	19.05	26.97	34.93	3.05	40.86
I/MS3100R 20*	1 1/4-18 UNEF	15.88	2.39 / 5.15	57.93	19.05	29.36	38.10	3.05	48.00
I/MS3100R 22*	1 3/8-18 UNEF	15.88	2.39 / 5.15	57.93	19.05	31.75	41.28	3.05	48.00
I/MS3100R 24*	1 1/2-18 UNEF	15.88	2.39 / 5.15	57.93	20.63	34.93	44.45	3.73	55.11
I/MS3100R 28*	1 3/4-18 UNS	15.88	2.39 / 5.15	57.93	20.63	39.67	50.80	3.73	55.11
I/MS3100R 32*	2-18 UNS	15.88	3.18 / 9.11	58.97	22.23	44.45	57.15	4.39	67.46
I/MS3100R 36*	2 1/4-16 UN	15.88	3.18 / 9.11	58.97	22.23	49.23	63.50	4.39	74.21

## I/MS3101A In-Line Receptacle

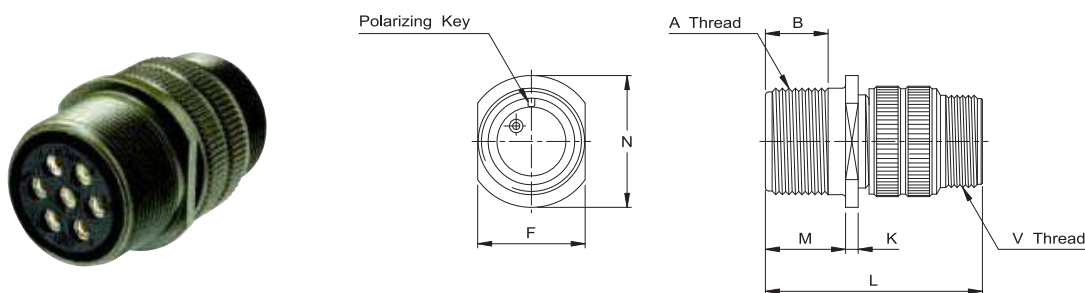

Part No.	A Thread Class 2A	B min.	F Ref.	K min./max.	L Ref.	M +0.79 -0.00	N dia. max.	V Thread Class 2A
I/MS3101A 10SL*	5/8-24 UNEF	9.53	16.66	1.58 / 3.96	38.88	14.28	24.61	5/8-24 UNEF
I/MS3101A 12S*	3/4-20 UNEF	9.53	19.43	1.58 / 3.96	42.87	14.28	26.97	5/8-24 UNEF
I/MS3101A 14S*	7/8-20 UNEF	9.53	22.61	1.58 / 3.96	42.87	14.28	29.36	3/4-20 UNEF
I/MS3101A 16S*	1-20 UNEF	9.53	25.78	1.58 / 3.96	42.87	14.28	31.75	7/8-20 UNEF
I/MS3101A 16*	1-20 UNEF	15.88	25.78	1.58 / 3.96	52.37	19.05	31.75	7/8-20 UNEF
I/MS3101A 18*	1 1/8-18 UNEF	15.88	28.96	2.39 / 5.15	52.37	19.05	34.13	1-20 UNEF
I/MS3101A 20*	1 1/4-18 UNEF	15.88	32.13	2.39 / 5.15	55.57	19.05	37.31	1 3/16-18 UNEF
I/MS3101A 22*	1 3/8-18 UNEF	15.88	35.31	2.39 / 5.15	55.57	19.05	40.48	1 3/16-18 UNEF
I/MS3101A 24*	1 1/2-18 UNEF	15.88	38.48	2.39 / 5.15	58.72	20.63	43.66	1 7/16-18 UNEF
I/MS3101A 28*	1 3/4-18 UNS	15.88	44.83	2.39 / 5.15	58.72	20.63	50.01	1 7/16-18 UNEF
I/MS3101A 32*	2-18 UNS	15.88	51.18	3.18 / 9.11	61.92	22.23	56.36	1 3/4-18 UNS
I/MS3101A 36*	2 1/4-16 UN	15.88	57.66	3.18 / 9.11	61.92	22.23	62.71	2-18 UNS

## I/MS3101E or F In-Line Receptacle

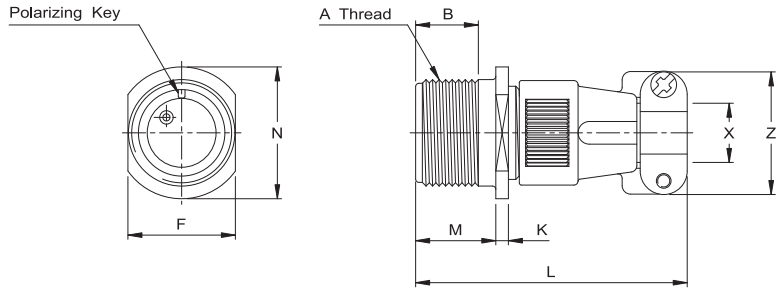

Part No.	A Thread Class 2A	B min.	F Ref.	K min./max.	L Ref.	M +0.79 -0.00	N dia. max.	X min. Cable- range	Z max.
I/MS3101E/F 10SL-*	5/8-24 UNEF	9.53	16.66	1.98 / 3.96	57.15	14.28	24.61	7.14	28.57
I/MS3101E/F 12S-*	3/4-20 UNEF	9.53	19.43	1.98 / 3.96	57.15	14.28	26.97	7.14	28.57
I/MS3101E/F 14S-*	7/8-20 UNEF	9.53	22.61	1.98 / 3.96	57.15	14.28	29.36	10.32	34.11
I/MS3101E/F 16S-*	1-20 UNEF	9.53	25.78	1.98 / 3.96	57.15	14.28	31.75	12.70	37.69
I/MS3101E/F 16-*	1-20 UNEF	15.88	25.78	1.98 / 3.96	66.67	19.05	31.75	12.70	37.69
I/MS3101E/F 18-*	1 1/8-18 UNEF	15.88	28.96	2.39 / 5.15	68.27	19.05	34.13	13.49	40.86
I/MS3101E/F 20-*	1 1/4-18 UNEF	15.88	32.13	2.39 / 5.15	69.85	19.05	37.31	16.67	48.00
I/MS3101E/F 22-*	1 3/8-18 UNEF	15.88	35.31	2.39 / 5.15	75.41	19.05	40.48	18.80	48.00
I/MS3101E/F 24-*	1 1/2-18 UNEF	15.88	38.48	2.39 / 5.15	75.41	20.63	43.66	19.84	55.11
I/MS3101E/F 28-*	1 3/4-18 UNS	15.88	44.83	2.39 / 5.15	76.98	20.63	50.01	23.42	55.11
I/MS3101E/F 32-*	2-18 UNS	15.88	51.18	3.18 / 9.11	76.98	22.23	56.36	29.36	67.46
I/MS3101E/F 36-*	2 1/4-16 UN	15.88	57.66	3.18 / 9.11	83.33	22.23	62.71	31.75	74.21

## I/MS3101R In-Line Receptacle

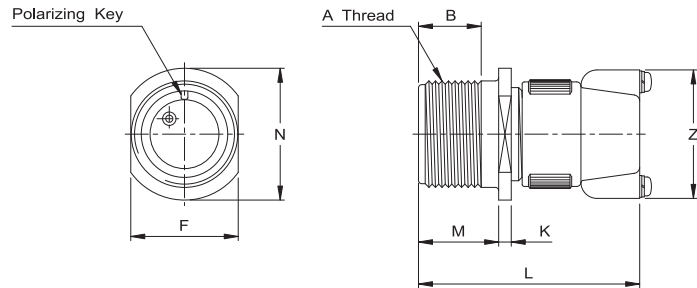

Part No.	A Thread Class 2A	B min.	F Ref.	K min./max.	L Ref.	M +0.79 -0.00	N dia. max.	Z max.
I/MS3101R 10SL-*	5/8-24 UNEF	9.53	16.66	1.98 / 3.96	46.68	14.28	24.61	28.57
I/MS3101R 12S-*	3/4-20 UNEF	9.53	19.43	1.98 / 3.96	46.68	14.28	26.97	28.57
I/MS3101R 14S-*	7/8-20 UNEF	9.53	22.61	1.98 / 3.96	46.68	14.28	29.36	34.11
I/MS3101R 16S-*	1-20 UNEF	9.53	25.78	1.98 / 3.96	46.68	14.28	31.75	37.69
I/MS3101R 16-*	1-20 UNEF	15.88	25.78	1.98 / 3.96	55.39	19.05	31.75	37.69
I/MS3101R 18-*	1 1/8-18 UNEF	15.88	28.96	2.39 / 5.15	57.93	19.05	34.13	40.86
I/MS3101R 20-*	1 1/4-18 UNEF	15.88	32.13	2.39 / 5.15	57.93	19.05	37.31	48.00
I/MS3101R 22-*	1 3/8-18 UNEF	15.88	35.31	2.39 / 5.15	57.93	19.05	40.48	48.00
I/MS3101R 24-*	1 1/2-18 UNEF	15.88	38.48	2.39 / 5.15	57.93	20.63	43.66	55.11
I/MS3101R 28-*	1 3/4-18 UNS	15.88	44.83	2.39 / 5.15	57.93	20.63	50.01	55.11
I/MS3101R 32-*	2-18 UNS	15.88	51.18	3.18 / 9.11	58.97	22.23	56.36	67.46
I/MS3101R 36-*	2 1/4-16 UN	15.88	57.66	3.18 / 9.11	58.97	22.23	62.71	74.21

## I/MS3102A or E Box Mounting Receptacle

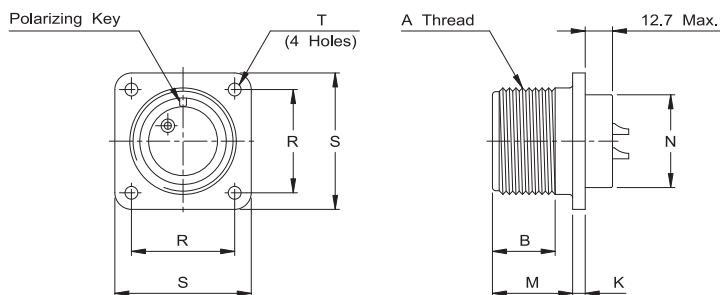

Part No.	A Thread Class 2A	B min.	K min./max.	M +0.79 -0.00	N dia. +0.00 -4.78	R ±0.12	S ±0.79	T dia +0.25 -0.12
I/MS3102A/E 10SL-*	5/8-24 UNEF	9.53	1.58 / 3.96	14.28	19.86	18.26	25.40	3.05
I/MS3102A/E 12S-*	3/4-20 UNEF	9.53	1.58 / 3.96	14.28	19.86	20.62	27.79	3.05
I/MS3102A/E 14S-*	7/8-20 UNEF	9.53	1.58 / 3.96	14.28	23.01	23.01	30.18	3.05
I/MS3102A/E 16S-*	1-20 UNEF	9.53	1.58 / 3.96	14.28	26.21	24.61	32.54	3.05
I/MS3102A/E 16*	1-20 UNEF	15.88	1.58 / 3.96	19.05	26.21	24.61	32.54	3.05
I/MS3102A/E 18*	1 1/8-18 UNEF	15.88	2.39 / 5.15	19.05	29.36	26.97	34.93	3.05
I/MS3102A/E 20*	1 1/4-18 UNEF	15.88	2.39 / 5.15	19.05	32.56	29.36	38.10	3.05
I/MS3102A/E 22*	1 3/8-18 UNEF	15.88	2.39 / 5.15	19.05	35.71	31.75	41.28	3.05
I/MS3102A/E 24*	1 1/2-18 UNEF	15.88	2.39 / 5.15	20.63	38.91	34.93	44.45	3.73
I/MS3102A/E 28*	1 3/4-18 UNS	15.88	2.39 / 5.15	20.63	45.26	39.67	50.80	3.73
I/MS3102A/E 32*	2-18 UNS	15.88	3.18 / 9.11	22.23	51.61	44.45	57.15	4.39
I/MS3102A/E 36*	2 1/4-16 UN	15.88	3.18 / 9.11	22.23	57.96	49.23	63.50	4.39

## I/MS3106A Straight Plug

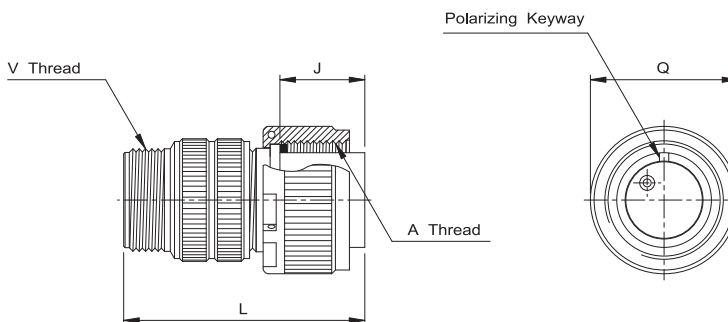

Part No.	A Thread Class 2B	J ±0.12	L Ref.	Q dia. Ref.	V Thread Class 2A
I/MS3106A 10SL-*	5/8-24 UNEF	13.49	38.88	24.61	5/8-24 UNEF
I/MS3106A 12S-*	3/4-20 UNEF	13.49	42.87	26.97	5/8-24 UNEF
I/MS3106A 14S-*	7/8-20 UNEF	13.49	42.87	29.36	3/4-20 UNEF
I/MS3106A 16S-*	1-20 UNEF	13.49	42.87	31.75	7/8-20 UNEF
I/MS3106A 16*	1-20 UNEF	18.26	52.37	31.75	7/8-20 UNEF
I/MS3106A 18*	1 1/8-18 UNEF	18.26	52.37	34.13	1-20 UNEF
I/MS3106A 20*	1 1/4-18 UNEF	18.26	55.57	37.31	1 3/16-18 UNEF
I/MS3106A 22*	1 3/8-18 UNEF	18.26	55.57	40.48	1 3/16-18 UNEF
I/MS3106A 24*	1 1/2-18 UNEF	18.26	58.72	43.66	1 7/16-18 UNEF
I/MS3106A 28*	1 3/4-18 UNS	18.26	58.72	50.01	1 7/16-18 UNEF
I/MS3106A 32*	2-18 UNS	18.26	61.92	56.36	1 3/4-18 UNS
I/MS3106A 36*	2 1/4-16 UN	18.26	61.92	62.71	2-18 UNS



## I/MS3106E or F Straight Plug

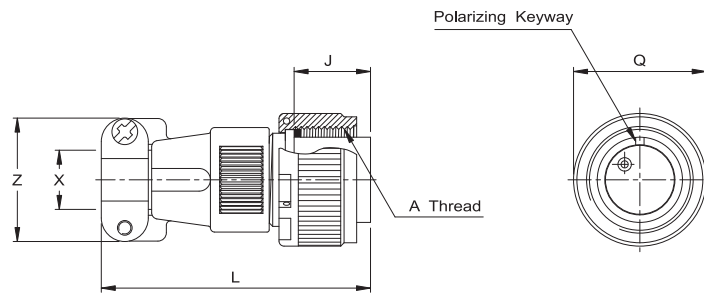

Part No.	A Thread Class 2B	J ±0.12	L Ref.	Q dia. Ref.	X min. Cable range	Z max.
I/MS3106E/F 10SL.*	5/8-24 UNEF	13.49	57.15	24.61	7.14	28.57
I/MS3106E/F 12S.*	3/4-20 UNEF	13.49	57.15	26.97	7.14	28.57
I/MS3106E/F 14S.*	7/8-20 UNEF	13.49	57.15	29.36	10.32	34.11
I/MS3106E/F 16S.*	1-20 UNEF	13.49	57.15	31.75	12.70	37.69
I/MS3106E/F 16.*	1-20 UNEF	18.26	66.67	31.75	12.70	37.69
I/MS3106E/F 18.*	1 1/8-18 UNEF	18.26	68.27	34.13	13.49	40.86
I/MS3106E/F 20.*	1 1/4-18 UNEF	18.26	69.85	37.31	16.67	48.00
I/MS3106E/F 22.*	1 3/8-18 UNEF	18.26	75.41	40.48	18.80	48.00
I/MS3106E/F 24.*	1 1/2-18 UNEF	18.26	75.41	43.66	19.84	55.11
I/MS3106E/F 28.*	1 3/4-18 UNS	18.26	76.98	50.01	23.42	55.11
I/MS3106E/F 32.*	2-18 UNS	18.26	76.98	56.36	29.36	67.46
I/MS3106E/F 36.*	2 1/4-16 UN	18.26	83.33	62.71	31.75	74.21

## I/MS3106R Straight Plug

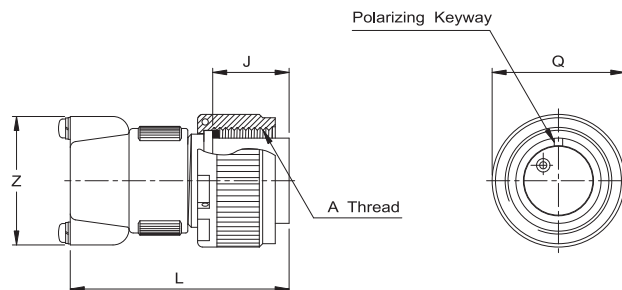

Part No.	A Thread Class 2B	J ±0.12	L Ref.	Q dia. Ref.	Z max.
I/MS3106R 10SL.*	5/8-24 UNEF	13.49	46.68	24.61	28.57
I/MS3106R 12S.*	3/4-20 UNEF	13.49	46.68	26.97	28.57
I/MS3106R 14S.*	7/8-20 UNEF	13.49	46.68	29.36	34.11
I/MS3106R 16S.*	1-20 UNEF	13.49	46.68	31.75	37.69
I/MS3106R 16.*	1-20 UNEF	18.26	55.39	31.75	37.69
I/MS3106R 18.*	1 1/8-18 UNEF	18.26	57.93	34.13	40.86
I/MS3106R 20.*	1 1/4-18 UNEF	18.26	57.93	37.31	48.00
I/MS3106R 22.*	1 3/8-18 UNEF	18.26	57.93	40.48	48.00
I/MS3106R 24.*	1 1/2-18 UNEF	18.26	57.93	43.66	55.11
I/MS3106R 28.*	1 3/4-18 UNS	18.26	57.93	50.01	55.11
I/MS3106R 32.*	2-18 UNS	18.26	58.97	56.36	67.46
I/MS3106R 36.*	2 1/4-16 UN	18.26	58.97	62.71	74.21

## I/MS3108A or R Right Angle Plug

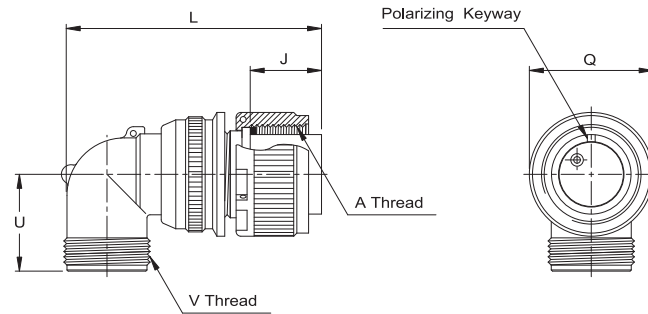

NOTE 1. MS3108R : with o-ring & wire grommet seal.

Part No.	A Thread Class 2B	J ±0.12	L max.	Q dia. Ref.	U max.	V Thread Class 2A
I/MS3108A 10SL*	5/8-24 UNEF	13.49	46.02	24.61	25.40	5/8-24 UNEF
I/MS3108A 12S*	3/4-20 UNEF	13.49	50.80	26.97	26.97	5/8-24 UNEF
I/MS3108A 14S*	7/8-20 UNEF	13.49	53.97	29.36	28.57	3/4-20 UNEF
I/MS3108A 16S*	1-20 UNEF	13.49	60.32	31.75	30.17	7/8-20 UNEF
I/MS3108A 16*	1-20 UNEF	18.26	65.07	31.75	30.17	7/8-20 UNEF
I/MS3108A 18*	1 1/8-18 UNEF	18.26	68.27	34.13	33.32	1-20 UNEF
I/MS3108A 20*	1 1/4-18 UNEF	18.26	76.98	37.31	34.92	1 3/16-18 UNEF
I/MS3108A 22*	1 3/8-18 UNEF	18.26	76.98	40.48	34.92	1 3/16-18 UNEF
I/MS3108A 24*	1 1/2-18 UNEF	18.26	86.51	43.66	39.67	1 7/16-18 UNEF
I/MS3108A 28*	1 3/4-18 UNS	18.26	86.51	50.01	39.67	1 7/16-18 UNEF
I/MS3108A 32*	2-18 UNS	18.26	95.25	56.36	47.62	1 3/4-18 UNS
I/MS3108A 36*	2 1/4-16 UN	18.26	100.02	62.71	52.37	2-18 UNS

## I/MS3108E or F Right Angle Plug

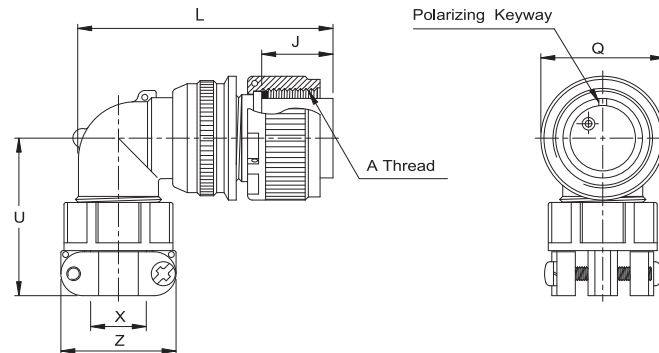

NOTE 1. I/MS3108E or F : with wire grommet seal 2. I/MS3108E : without O-ring, I/MS3108F : with O-ring

Part No.	A Thread Class 2B	J ±0.12	L max.	Q dia. Ref.	U max.	X dia (Free) max.	Z ±0.78
I/MS3108E/R 10SL*	5/8-24 UNEF	13.49	46.02	24.61	38.30	7.92	22.23
I/MS3108E/R 12S*	3/4-20 UNEF	13.49	50.80	26.97	38.30	7.92	22.23
I/MS3108E/R 14S*	7/8-20 UNEF	13.49	53.97	29.36	44.45	11.13	26.97
I/MS3108E/R 16S*	1-20 UNEF	13.49	60.32	31.75	41.48	14.27	29.36
I/MS3108E/R 16*	1-20 UNEF	18.26	65.07	31.75	41.48	14.27	29.69
I/MS3108E/R 18*	1 1/8-18 UNEF	18.26	68.27	34.13	44.68	15.88	31.75
I/MS3108E/R 20*	1 1/4-18 UNEF	18.26	76.98	37.31	49.05	19.05	37.31
I/MS3108E/R 22*	1 3/8-18 UNEF	18.26	76.98	40.48	50.62	19.05	37.31
I/MS3108E/R 24*	1 1/2-18 UNEF	18.26	86.51	43.66	53.82	23.83	42.88
I/MS3108E/R 28*	1 3/4-18 UNS	18.26	86.51	50.01	55.40	23.83	42.88
I/MS3108E/R 32*	2-18 UNS	18.26	95.25	56.36	65.28	31.75	51.59
I/MS3108E/R 36*	2 1/4-16 UN	18.26	100.02	62.71	68.45	34.93	57.94

## I/MS3057-■ ■ A Cable Clamp

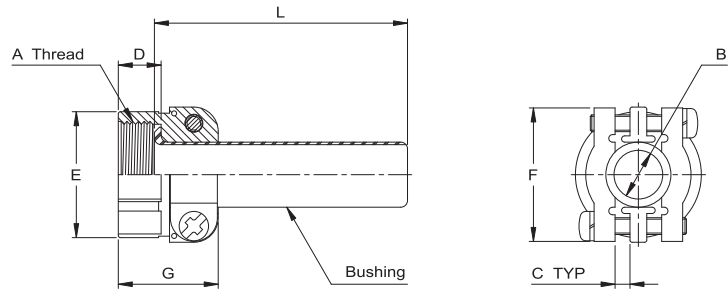

Part No.	Connector Shell Size	A Thread Class 2B	B dia. ±0.41	C TYP	D	E dia. ±0.79	F ±0.79	G ±0.79	L Ref.	Bushing Ref.
I/MS3057 - 4A	10SL, 12S & 12	5/8-24 UNEF	5.59	1.57	10.31	20.62	22.23	20.62	69.9	MS3420 - 4
I/MS3057 - 6A	14S & 14	3/4-20 UNEF	7.92	1.98	10.31	24.61	26.97	22.22	66.7	MS3420 - 6
I/MS3057 - 8A	16S & 16	7/8-20 UNEF	11.10	2.77	10.31	27.79	29.36	23.82	63.5	MS3420 - 8
I/MS3057 - 10A	18	1-20 UNEF	14.27	3.18	10.31	30.18	31.75	23.82	60.3	MS3420 - 10
I/MS3057 - 12A	20, 22	1 3/16-18 UNEF	15.88	3.96	10.31	34.93	37.31	23.82	57.2	MS3420 - 12
I/MS3057 - 16A	24, 28	1 7/16-18 UNEF	19.05	4.78	10.31	42.06	42.88	26.18	54.0	MS3420 - 16
I/MS3057 - 20A	32	1 3/4-18 UNS	23.80	6.35	11.91	51.59	51.59	27.78	50.8	MS3420 - 20
I/MS3057 - 24A	36	2-18 UNS	31.75	7.54	13.49	56.36	57.94	29.36	47.6	MS3420 - 24

## I/MS3420 Telescoping Bushing

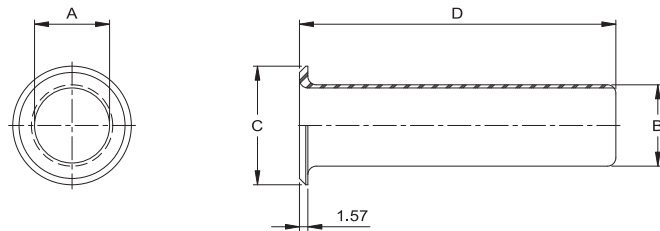

Part No.	Connector Shell Size	A dia. ±0.41	B dia. ±0.41	C dia. ±0.41	D ±0.41	Cable Clamp Ref.
I/MS3420 - 4	10SL, 12S & 12	5.59	7.67	12.83	69.85	MS3057 - 4A
I/MS3420 - 6	14S & 14	7.92	10.85	15.72	66.68	MS3057 - 6A
I/MS3420 - 8	16S & 16	11.10	14.02	18.90	63.50	MS3057 - 8A
I/MS3420 - 10	18	14.27	15.62	22.58	60.33	MS3057 - 10A
I/MS3420 - 12	20, 22	15.88	18.80	27.53	57.15	MS3057 - 12A
I/MS3420 - 16	24, 28	19.05	23.55	33.38	53.98	MS3057 - 16A
I/MS3420 - 20	32	23.80	31.50	40.59	50.80	MS3057 - 20A
I/MS3420 - 24	36	31.75	34.67	46.91	47.63	MS3057 - 24A

## I/MS25043 Protective Cover for Receptacle

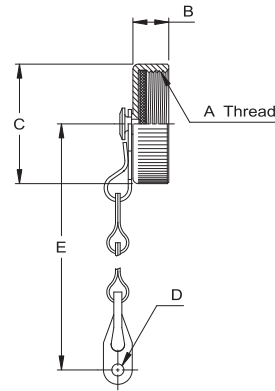

Part No.	Connector Shell Size	A Thread Class 2B	B max.	C dia. max.	D dia. +0.25 -0.13	E ±21.0
I/MS25043 - 10D	10S, 10SL	5/8-24 UNEF	11.91	20.70	3.56	101.6
I/MS25043 - 12D	12S, 12	3/4-20 UNEF	11.91	25.40	3.56	114.3
I/MS25043 - 14D	14S, 14	7/8-20 UNEF	11.91	28.58	3.56	114.3
I/MS25043 - 16D	16S, 16	1-20 UNEF	11.91	30.18	3.56	114.3
I/MS25043 - 18D	18	1 1/8-18 UNEF	11.91	34.14	3.56	114.3
I/MS25043 - 20D	20	1 1/4-18 UNEF	11.91	37.31	3.56	127.0
I/MS25043 - 22D	22	1 3/8-18 UNEF	11.91	40.49	3.56	127.0
I/MS25043 - 24D	24	1 1/2-18 UNEF	11.91	43.66	4.34	139.7
I/MS25043 - 28D	28	1 3/4-18 UNS	13.49	50.01	4.34	196.8
I/MS25043 - 32D	32	2-18 UNS	13.49	56.36	4.75	196.8
I/MS25043 - 36D	36	2 1/4-16 UN	13.49	62.71	4.75	196.8

## I/MS25042 Protective Cover for Plug

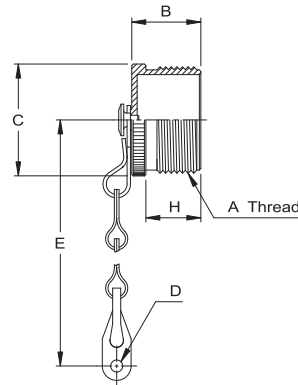

Part No.	Connector Shell Size	A Thread Class 2A	B max.	C dia. max.	D dia. +0.25 -0.13	E ±21.0	H min.
I/MS25042 - 10D	10S, 10SL	5/8-24 UNEF	16.66	17.45	3.96	101.6	9.65
I/MS25042 - 12D	12S, 12	3/4-20 UNEF	21.44	20.62	3.96	114.3	16.00
I/MS25042 - 14D	14S, 14	7/8-20 UNEF	21.44	23.80	3.96	114.3	16.00
I/MS25042 - 16D	16S, 16	1-20 UNEF	21.44	26.97	3.96	114.3	16.00
I/MS25042 - 18D	18	1 1/8-18 UNEF	21.44	30.15	3.96	114.3	16.00
I/MS25042 - 20D	20	1 1/4-18 UNEF	21.44	33.32	4.75	127.0	16.00
I/MS25042 - 22D	22	1 3/8-18 UNEF	21.44	36.50	4.75	127.0	16.00
I/MS25042 - 24D	24	1 1/2-18 UNEF	21.44	39.67	4.75	139.7	16.00
I/MS25042 - 28D	28	1 3/4-18 UNS	21.44	46.02	4.75	196.8	16.00
I/MS25042 - 32D	32	2-18 UNS	21.44	52.37	5.54	196.8	16.00
I/MS25042 - 36D	36	2 1/4-16 UN	21.44	58.72	5.54	196.8	16.00