



- ⊗ IP68 rated
- ⊗ IP69K, Tested in accordance with DIN 40050/Part 9 IP6k9k
- ⊗ USB version 2.0 performance
- ⊗ Plug and play capability
- ⊗ Visual mating indication
- ⊗ Shielded system
- ⊗ Single and double ended cables
- ⊗ Screw coupling
- ⊗ PCB versions
- ⊗ Dust and waterproof sealing when mated
- ⊗ Low and high speed bus connection, 1.5Mbps to 480Mbps
- ⊗ Hot pluggable, standard 4 pole interface
- ⊗ Alignment indicator reduces risk of damage during mating
- ⊗ High noise immunity and EMI protection
- ⊗ Suitable for PC and peripheral configuration
- ⊗ Secure, proven locking system
- ⊗ Direct mounting or via adaptor leads
- ⊗ EN60068-2-52 Test Kb Salt Mist (Cyclic) Marine Severity Level 1

Sealed USB Cables - Single Ended



PX0840/A



PX0840/B

- Single ended sealed cable assembly**
- IP68 'A' type USB connector to standard 'B' type USB connector, mates with all panel mount connectors
 - IP68 'B' type USB connector to standard 'A' type USB connector, mates with all panel mount connectors
 - Available in 2m, 3m and 5m lengths

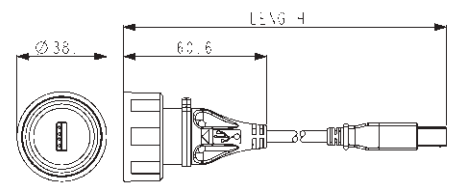

PX0840/A/xMxx

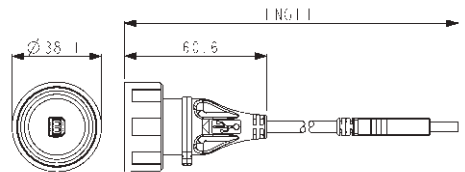

PX0840/B/xMxx

Part no.	Length	Description
PX0840/A/2M00	2m	IP68 A type USB to standard B type USB
PX0840/A/3M00	3m	IP68 A type USB to standard B type USB
PX0840/A/5M00	5m	IP68 A type USB to standard B type USB
PX0840/B/2M00	2m	IP68 B type USB to standard A type USB
PX0840/B/3M00	3m	IP68 B type USB to standard A type USB
PX0840/B/5M00	5m	IP68 B type USB to standard A type USB

Sealed USB Cables Double Ended



PX0841/AB

- Double ended sealed cable assembly**
- IP68 'A' type USB connector to
 - IP68 'B' type USB connector
 - Mates with all panel mount connectors
 - Available in 2m, 3m and 5m lengths

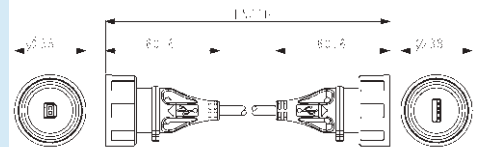

PX0841/AB/xMxx

Part no.	Length	Description
PX0841/AB/2M00	2m	IP68 A type USB to IP68 B type USB
PX0841/AB/3M00	3m	IP68 A type USB to IP68 B type USB
PX0841/AB/5M00	5m	IP68 A type USB to IP68 B type USB

Front Panel Mounting Connector



PX0842/A

PX0842/B

- PX0842/A - USB 'A' type IP68 connector
- PX0842/B - USB 'B' type IP68 connector
- Opposite connector to rear of panel
- Mates with PX0840 and PX0841 cable connectors

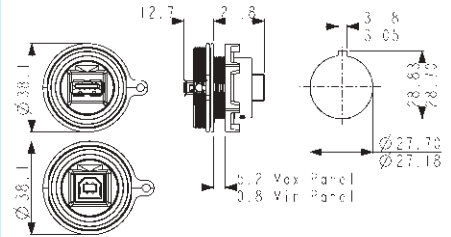

Part no.

Description

PX0842/A	IP68 A type USB, front panel mounted. Sealed A type at front of panel, standard B type at rear
PX0842/B	IP68 B type USB, front panel mounted. Sealed B type at front of panel, standard A type at rear.

Front Panel Mounting Connector



PX0843/A

PX0843/B

- PX0843/A - USB 'A' type IP68 connector
- PX0843/B - USB 'B' type IP68 connector
- Leaded with 5 way crimp connector
- Mates with PX0840 and PX0841 cable connectors

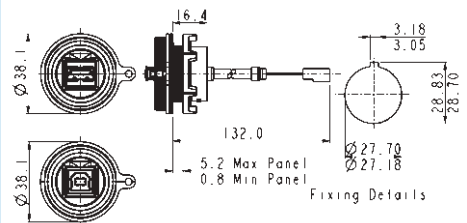

Part no.

Description

PX0843/A	IP68 A type USB, front panel mounted. Sealed A type at front of panel, 5 way crimp connector at rear.
PX0843/B	IP68 B type USB, front panel mounted. Sealed B type at front of panel, 5 way crimp connector at rear.
PX0460/A	As PX0843/A with exposed braid for use with PX0465 screening can
PX0460/B	As PX0843/B with exposed braid for use with PX0465 screening can

Front Panel Mounting Connector



PX0844/A

PX0844/B

- IP68 Sealed through panel
- PX0844/A - USB 'A' type IP68 connector
- PX0844/B - USB 'B' type IP68 connector
- Standard USB interface plug options to rear of panel
- 500mm standard cable length, other lengths available
- Mates with PX0840 and PX0841 cable connectors

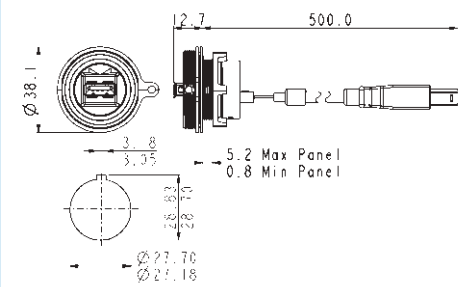

Part no.

Description

PX0844/A/0M50/A	IP68 A type USB, sealed through panel, Sealed 'A' type at front of panel, standard 'A' type at rear
PX0844/A/0M50/B	IP68 A type USB, sealed through panel, Sealed 'A' type at front of panel, standard 'B' type at rear
PX0844/B/0M50/A	IP68 B type USB, sealed through panel, Sealed 'B' type at front of panel, standard 'B' type at rear
PX0844/B/0M50/B	IP68 B type USB, sealed through panel, Sealed 'B' type at front of panel, standard 'B' type at rear

Rear Panel Mounting Connector



PX0848/A

PX0848/B

- PX0848/A - USB 'A' type IP68 connector
- PX0848/B - USB 'B' type IP68 connector
- Opposite connector to rear of panel
- Mates with PX0840 and PX0841 cable connectors

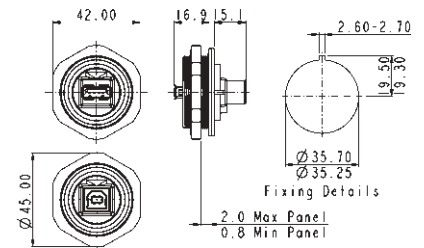

Part no. **Description**

PX0848/A	IP68 A type USB, rear panel mounted. Sealed A type at front of panel, standard B type at rear.
PX0848/B	IP68 B type USB, rear panel mounted. Sealed B type at front of panel, standard A type at rear.

Rear Panel Mounting Connector



PX0849/A

PX0849/B

- PX0849/A - USB 'A' type IP68 connector
- PX0849/B - USB 'B' type IP68 connector
- Leaded with 5 way header
- Mates with PX0840 and PX0841 cable connectors

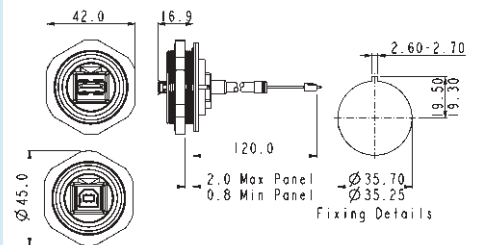

Part no. **Description**

PX0849/A	IP68 A type USB, rear panel mounted. Sealed A type at front of panel, 5 way header at rear.
PX0849/B	IP68 B type USB, rear panel mounted. Sealed B type at front of panel, 5 way header at rear.

PCB Panel Mounting Connector- PCB Direct Mount



PX0845/A

PX0845/B

- PX0845/A - USB 'A' type IP68 connector
- PX0845/B - USB 'B' type IP68 connector
- PCB contacts at rear
- Direct PCB mount
- Mates with PX0840 and PX0841 cable connectors

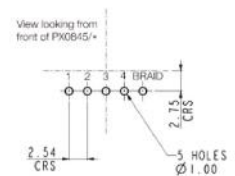
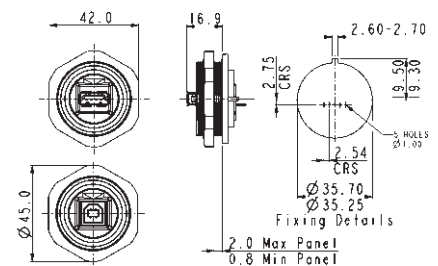

Part no. **Description**

PX0845/A	IP68 A type USB, rear panel mounted. Sealed A type at front of panel, direct mount PCB contacts at rear.
PX0845/B	IP68 B type USB, rear panel mounted. Sealed B type at front of panel, direct mount PCB contacts at rear.

PCB Adaptor Leads



- Standard A and B type USB connectors to 5 way crimp adaptor leads
- 5 way headers, 2.54mm pitch, horizontal or vertical mounting

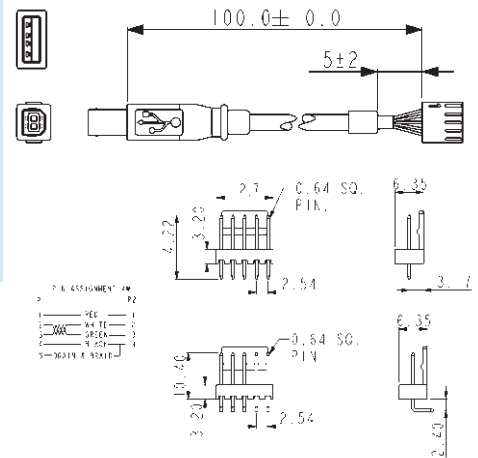

Part no. **Description**

14193	USB 'A' type to 5 way crimp connector
14194	USB 'B' type to 5 way crimp connector
14191	5 way PCB header straight
14192	5 way PCB header right angle

Accessories



- Sealing caps to maintain IP68 rating when connectors are not in use
- PX0835 for cable connectors PX0840 & PX0841
- PX0733 for front panel mount connectors PX0842, PX0843 & PX0844
- PX0711 for rear panel mount connectors PX0848, PX0849 & PX0845

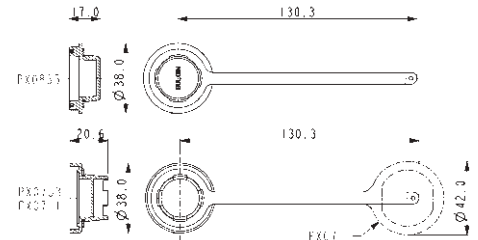

Part no. **Description**

PX0835	Sealing Cap for cable connectors (PX0840, PX0841)
PX0733	Sealing Cap for front panel mounting connector (PX0842, PX0843)
PX0711	Sealing Cap for rear panel mounting connector (PX0848, PX0849, PX0845)

USB Flash Drive Cover



PX0852

- For use with USB Flash Drives
- Maintains IP68 rating when mated with panel connector
- For use with 'A' type connectors: PX0842, PX0843, PX0845, PX0848 & PX0849
- Internal accommodation 17.5 x 14.0 x 83mm approx.

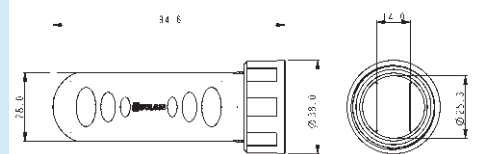

Screening Can



PX0464

- Maintains cable screening directly to panel
- Screening can clips around the panel fixing nut
- For use on PX0460/A and PX0460/B

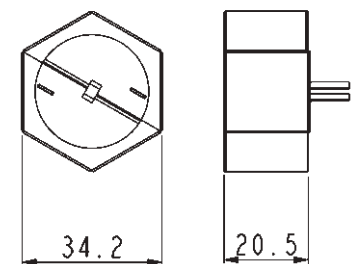

Cables & connectors

Mechanical	IP69K, Tested in accordance with DIN 40050/Part 9 IP6k9k
	IP68, EN60529:1992+A2:2013 (10m depth for 2 weeks)
Operating temperature	0°C to +70°C
Salt Mist	EN60068-2-52 Test Kb Salt Mist (Cyclic) Marine Severity Level 1
Electrical	
No. of poles	4
Current rating	1A
Voltage rating	30Vac (RMS)
Contact resistance	30m Ω max.
Performance	USB version 2.0

Materials - Overmoulded

Overmould material	PVC (black)
Flammability rating	UL94V-0

Materials - Re-wireable and Panel Connectors

Shell material	Steel
Shell plating	Nickel
Contact material	Copper Alloy
Contact plating	30 micro inch Gold
Connector body & locking ring	Glass Loaded Polyester
Panel connector	Nylon 6
Flammability rating	UL94V-0
'O' rings	Silicone
Panel Gasket - round	Silicone
Panel Gasket - square	Neoprene
Mating cycles	1,000
RoHS	Compliant

Materials - cable

Cable Jacket	PVC (black)
Screen	Tinned copper braid
Flammability	UL94V-0
RoHS	Compliant

Length:	Dia	Conductors Signal	Conductors Power
2m	4.8mm	2 x 28AWG	2 x 24AWG
3m	5.0mm	2 x 28AWG	2 x 22AWG
5m	5.2mm	2 x 25AWG	2 x 20AWG

PCB adaptor leads

Electrical	
No. of conductors	4
Current rating	1A
Voltage rating	30Vac (RMS)
Contact resistance	<10m Ω max.
PCB pitch	2.54mm

Materials

Moulding	Polycarbonate
Flammability	UL94V-0
Contact material	Copper Alloy
Contact plating	30 micro inch Gold
Wire insulation	PVC (black)
Flammability	UL94-V0
Conductors	4 x 28AWG
Operating temperature	0°C to +70°C
Mating cycles	1,000
RoHS	Compliant

Cable construction - PX0840, PX0841

